

Article number: 0106044

Description: Retaining ring JV 27

Measures

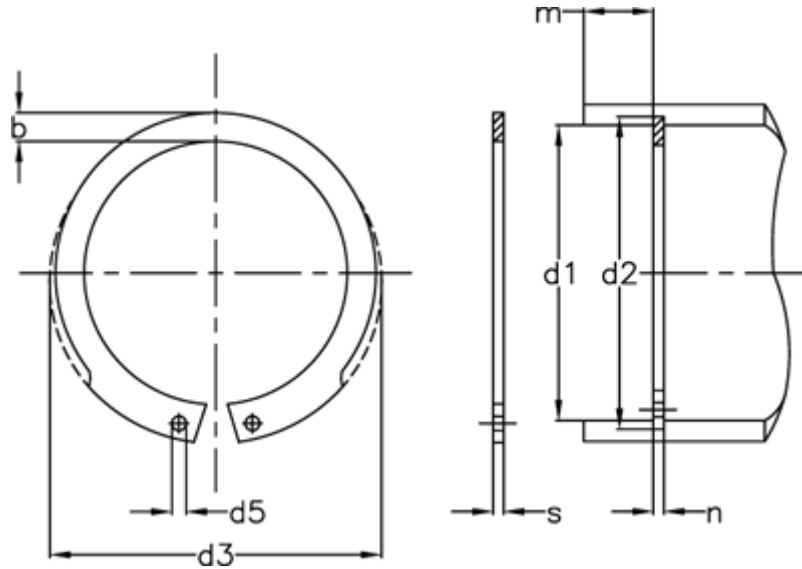

AN mm ²	= 30	FRg kN	= 5.1	tol	= 0.1
b	= 3.0	FR kN	= 15.0	tol	= -0.06
d1	= 27	g	= 1.0	tol	= +0,42-0,21
d2	= 28.4	K kN-mm	= 29.9	tol	= +0,21
d3	= 29.1	m min	= 1.30	Tong	= ZGJ-1
d5 min	= 1.5	Nominal drive	= 2.1	Weight kg/1000	= 1.53
Description	= JV 27	s	= 1.20		
FN kN	= 5.00	t	= 0.70		